

Delivering leading edge, innovative power solutions for more than 30 years....

Model:GT-86120-WWVV-X.X-W2U

November 30, 2021

GT-86120-WWVV-X.X-W2U

Information

Model Number

GT-86120-WWVV-X.X-W2U

Description

GT-86120-WWVV-X.X-W2U, ICT/ITE Power Supply, Wall Plug-in, Regulated Switchmode AC-DC Power Supply AC Adaptor, , Input Rating: 100-240V- , 50/60Hz, UK BS 1363, 2 Blade w/Dummy Ground Class II, Output Rating: 12 Watts, Power rating with convection cooling (W) , 4.2V-12VV in 0.1V increments, Approvals: EAC; UKCA; CE; CB 60950; UKCA; China RoHS; Double Insulation; Level VI; LPS 60950; RoHS; CB 62368; Ukraine; LPS 62368; WEEE;

Model Picture



Agency Documents

<http://www.globtek.info/certs/GT-86120-WWVV-W2Z/>

CE EC-Declaration

https://www.globtek.com/pdf/ec_declaration/a00a000000jT6DEAV

RoHS/RoHS2 Declaration

https://www.globtek.com/pdf/rohs_cert/a00a000000jT6DEAV

REACH Declaration

https://www.globtek.com/pdf/iso_certificates/REACH.pdf

Conflict Minerals Declaration

<https://www.globtek.com/pdf/conflict-minerals.pdf>

Delivering leading edge, innovative power solutions for more than **30** years....

Model:GT-86120-WWVV-X.X-W2U

November 30, 2021

MODEL PARAMETERS

Type	Wall Plug-in
Technology	Regulated Switchmode AC-DC Power Supply AC Adaptor
Category	ICT/ITE Power Supply
Input Voltage	100-240V~, 50/60Hz
I/P Amps (A)	0.5A
Wattage (W)	12.0
Vout Range (V)	4.2V-12V
Efficiency Level	USA DOE Level VI / Eco-design Directive 2009/125/EC, (EU) 2019/1782
Ingress Protection	IPX0
Size (mm)	69*49*49

Delivering leading edge, innovative power solutions for more than 30 years....

Model:GT-86120-WWVV-X.X-W2U

November 30, 2021

ENCLOSURE

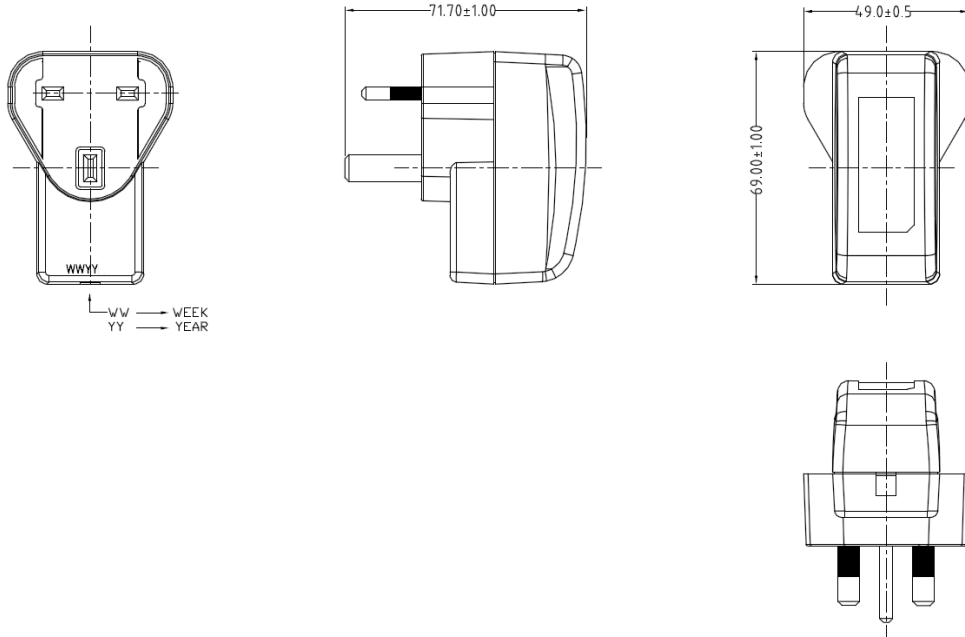

br

Delivering leading edge, innovative power solutions for more than **30** years....

Model:GT-86120-WWVV-X.X-W2U

November 30, 2021

RATING TABLE

Model Number	Voltage	Amps(A)	Watts(W)	RFQ
GT-86120-1005-W2U	5 V	2	10.00	RFQ
GT-86120-1212-6.05-W2U	5.95 V	1.68	10.00	RFQ
GT-86120-1012-3.0-W2U	9 V	1.1	9.90	RFQ
GT-86120-0912-3.0-W2U	9 V	1	9.00	RFQ
GT-86120-1212-W2U	12 V	1	12.00	RFQ

Delivering leading edge, innovative power solutions for more than 30 years....

Model:GT-86120-WWVV-X.X-W2U

November 30, 2021

SPECIFICATIONS

ELECTRICAL SPECIFICATIONS:

01. Input Voltage: Specified 90-264 Vac, Nameplate rated: 100-240Vac
02. Input Frequency: Specified 47-63 Hz, Nameplate rated 50-60Hz
03. Output Regulation: +/- 5%
04. Ripple and Noise (Vp-p): 100 mVp-p maximum, At 20 MHz, and output parallel with 0.1uF & 47uF capacitors to ground. Temperature at 25 °C, and nominal input voltage
05. Efficiency: Compliant with Efficiency Level VI and ErP European Commission's Ecodesign Directive (2005/32/EC) / CoC Tier 2 Compliant
06. No Load Standby Power: <0.075W @ 230Vac
07. Turn-ON Delay: 3 Seconds maximum at nominal input voltage
08. Rise Time: 100mS maximum at nominal input voltage

B) PROTECTION

01. Over-Voltage: 10VDC maximum
02. Over current protection: 4A maximum with auto-recovery function
03. Short Circuit: Short circuit protection is to be included in the construction of the adaptor. The adaptor is designed to withstand continuous current of a short circuit on the output. The adaptor will be short circuit tolerant for an indefinite period.

C) SAFETY

01. Dielectric Withstand Voltage: 3000VAC 10mA 1minute or 4242VDC 10mA 1minute from primary to secondary
02. Leakage current: 0.25mA maximum, at nominal AC input voltage and frequency
03. Static Discharge Immunity of 8kV Contact Discharge, 15kV air discharge.

D) EMC

01. Emissions, per EN 55032, EN 61000-6-3, EN 61000-6-4
 - Conducted Emissions: Class B, FCC Part 15, Class B
 - Radiated Emissions: Class B, FCC Part 15, Class B
02. Line Frequency Harmonics EN61000-3-2, Class A
03. Voltage Fluctuations/Flicker EN61000-3-3
04. Immunity, per EN 55024, EN 61000-6-1, EN 61000-6-2
 - Static Discharge Immunity EN61000-4-2, 4kV Contact Discharge, 8kV air discharge
 - Radiated RF Immunity EN61000-4-3, 3V/m 80-1000MHz, 80% 1KHz AM.
 - EFT/Burst Immunity EN61000-4-4, 1kV/100kHz.
 - Line Surge Immunity EN61000-4-5, 1kV differential, 2kV common-mode
 - Conducted RF Immunity EN61000-4-6, 3Vrms, 80% 1KHz AM
 - Power Frequency Magnetic Field Immunity EN61000-4-8, 1A/m
 - Voltage Dip Immunity EN61000-4-11, Criteria

E) OTHER:

01. MTBF: 200,000 Hours @ 25°C ambient temperature
02. Operating Temperature: 0°C to 50°C ambient temperature (RFP7139)
03. Humidity: 5% to 90% relative humidity
04. Storage Temperature: -20°C to 60°C
05. Cooling: natural convection cooling
06. ROHS 2: Complies with EU 2011/65/EU and China SJ/T 11363-2006

PROPRIETARY INFORMATION

PROPRIETARY OF GLOBTEK, INC. ANY REPRODUCTION, DISCLOSURE OR USE OF THIS DRAWING, IN WHOLE OR IN PART, IS HEREBY PROHIBITED EXCEPT AS SPECIFIED IN WRITING BY GLOBTEK, INC.

<https://www.globtek.com/datasheet/w71160>

Delivering leading edge, innovative power solutions for more than **30** years....

Model:GT-86120-WWVV-X.X-W2U

November 30, 2021

F) ENCLOSURE

01. Housing: High impact plastic, 94V0 polycarbonate, non-vented

02. Markings: Label and/or Pad Printed and/or Molded in the case

Delivering leading edge, innovative power solutions for more than 30 years....

Model:GT-86120-WWVV-X.X-W2U

November 30, 2021

DERATING CURVE

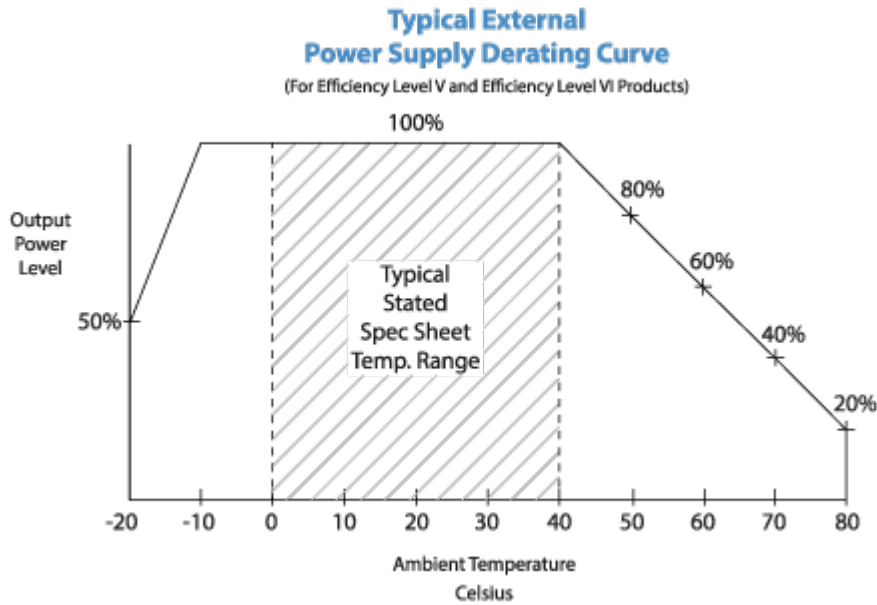

Delivering leading edge, innovative power solutions for more than 30 years....

Model:GT-86120-WWVV-X.X-W2U

November 30, 2021

INPUT CONFIGURATION

Description UK BS 1363, 2 Blade w/Dummy Ground Class II

The line and neutral pins have a rectangular cross section 6.35 mm by 4.0 mm, 17.7 mm long and with centres 22.2 mm apart. The protective-earth pin is a rectangular cross section 8.0 mm by 4.0 mm, 22.3 mm long and with a centre line 22.2 mm from the line/neutral pin centre line. The dimensions were originally specified in decimal inches with asymmetric tolerances and redefined as minimum and maximum metric dimensions in BS 1363:1984.

Dimensions are chosen to provide safe clearance to live parts. The distance from any part of the line and neutral pins to the periphery of the plug base must be not less than 9.5 mm. This ensures that nothing can be inserted alongside a pin when the plug is in use, and helps keep fingers away from the pins. The minimum insertion distance from the face of the socket-outlet to the first point of contact with a live part is 9.6 mm.

The "Dummy" longer earth pin ensures that the earth path is connected before the live pins, and remains connected after the live pins are removed. The earth pin is too large to be inserted into the line or neutral sockets by mistake.

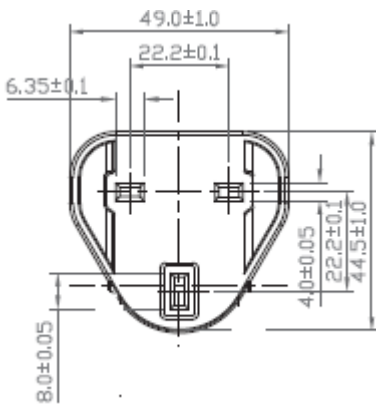

Delivering leading edge, innovative power solutions for more than 30 years....

Model:GT-86120-WWVV-X.X-W2U

November 30, 2021

OUTPUT CONFIGURATION

Common output connector options:

 L Type (Coaxial
5.5x2.5mm plug)

 C Type (Coaxial
5.5x2.1mm plug)

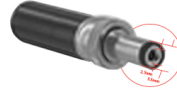
 K Type (Coaxial
3.5x1.3mm plug)

 LL Type (5.5x2.5mm
Locking 760k type)

 CL Type (5.5x2.1mm
Locking S761k type)

 ML2 Type (Molex
housing 43025-0200)

 YL3 Type
(KPPX-3P)

YL4 Type (KPPX-4P)

 EJ1/2/3/4/5 (EIAJ
RC-5320A type
connectors)

 MSB Type (Micro
USB)

 USBC Type (USB
Type C)

 Inquire for custom
design

 For a comprehensive list of options, [click here](#)







Contact GlobTek for your specific requirements or custom solutions.

Delivering leading edge, innovative power solutions for more than 30 years....

Model:GT-86120-WWVV-X.X-W2U

November 30, 2021





Approvals

Logo	Description
	Attention Mark / Refer to operating manual for operating and service instructions
No Logo Applicable	CB report to IEC 60950-1:2005 (2nd Edition) +A1:2009 + A2:2013
No Logo Applicable	CB for IEC 62368-1:2014 (Second Edition)
	CE Certification
	CHINA SJ/T 11364-2014, China RoHS Chart: http://en.globtek.com/globtek-rohs.php
Conforms to UL STD. 62368-1 Certified to CSA STD C22.2 NO.62368-1	Conforms to UL STD. 62368-1 Certified to CSA STD C22.2 NO.62368-1
	
	Declaration ДС № EAЭC N RU Д-US.KA01.B.10453_19 Custom Union of Russia, Belarus and Kazakhstan http://www.globtek.com/redirect/?loc=gost-certificate-eac-declaration
	Indoor Use Only - Mark is on the label or Molded in the case
EFFICIENCY LEVEL 	Efficiency: complies to section 301 of Energy Independence and Security Act (EISA) complies with Energy Star tier 2 (North America), ECP tier 2 (China), MEPS tier 2 (Australia), Code of Conduct (Europe)
LPS	Limited Power Source 60950

Delivering leading edge, innovative power solutions for more than **30** years....

Model:GT-86120-WWVV-X.X-W2U

November 30, 2021

LPS	Limited Power Source 62368
RoHS	Specifications of directive 2011/65/EU Annex VI (ROHS-2) with amendment 2015/863-EU (ROHS-3) http://www.ce-mark.com/Rohs%20final.pdf
	UKCA Certification
	UKCA Certification
	Ukraine UKRSepro (Document: www.globtek.com/html/iso_certificates/GT_Ukraine.pdf)
	WEEE: Complies with EU 2012/19/EU (http://ec.europa.eu/environment/waste/wEEE/index_en.htm) Mark is on the label or Molded in the case