

Delivering leading edge, innovative power solutions for more than **30** years....

Model:GT-46240-24VV-x.x-T3

June 1, 2020

GT-46240-24VV-x.x-T3

Information

Model Number

GT-46240-24VV-x.x-T3

Description

GT-46240-24VV-x.x-T3, ITE Power Supply, Desktop/External, Regulated Switchmode AC-DC Power Supply AC Adaptor, , Input Rating: 100-240V~, 50-60 Hz, IEC 60320/C14 AC Inlet Connector, Class I, Earth Ground, Output Rating: 24 Watts, Power rating with convection cooling (W) , 12-24V in 0.1V increments, Approvals: India; cULus; S-Mark 60950; 230V CoC Tier 2; EAC; Morocco; CB 62368; CE; China RoHS; Class I; IP52; Level VI; LPS 60950; VCCI; PSE; RoHS; Ukraine; WEEE; RCM; CAN ICES-3; Korea (24V, 20V and 18V Only); CCC;

Model Picture



Agency Documents

<http://www.globtek.info/certs/GT-46240-24VV-x.x-TZ/>

CE EC-Declaration

https://www.globtek.com/pdf/ec_declaration/a0Oa000000MjLiqEAF

RoHS/RoHS2 Declaration

https://www.globtek.com/pdf/rohs_cert/a0Oa000000MjLiqEAF

REACH Declaration

https://www.globtek.com/pdf/iso_certificates/REACH.pdf

Conflict Minerals Declaration

<https://www.globtek.com/pdf/conflict-minerals.pdf>

Delivering leading edge, innovative power solutions for more than **30** years....

Model:GT-46240-24VV-x.x-T3

June 1, 2020

MODEL PARAMETERS

Type	Desktop/External
Technology	Regulated Switchmode AC-DC Power Supply AC Adaptor
Category	ITE Power Supply
Input Voltage	100-240V~, 50-60 Hz
I/P Amps (A)	0.6 A
Wattage (W)	24.0
Vout Range (V)	12-24
Efficiency Level	USA DOE Level VI / Eco-design Directive 2009/125/EC, (EU) 2019/1782
Ingress Protection	Indoor Use
Size (mm)	80.6*50.0*31.0

Delivering leading edge, innovative power solutions for more than 30 years....

Model:GT-46240-24VV-x.x-T3

June 1, 2020

ENCLOSURE

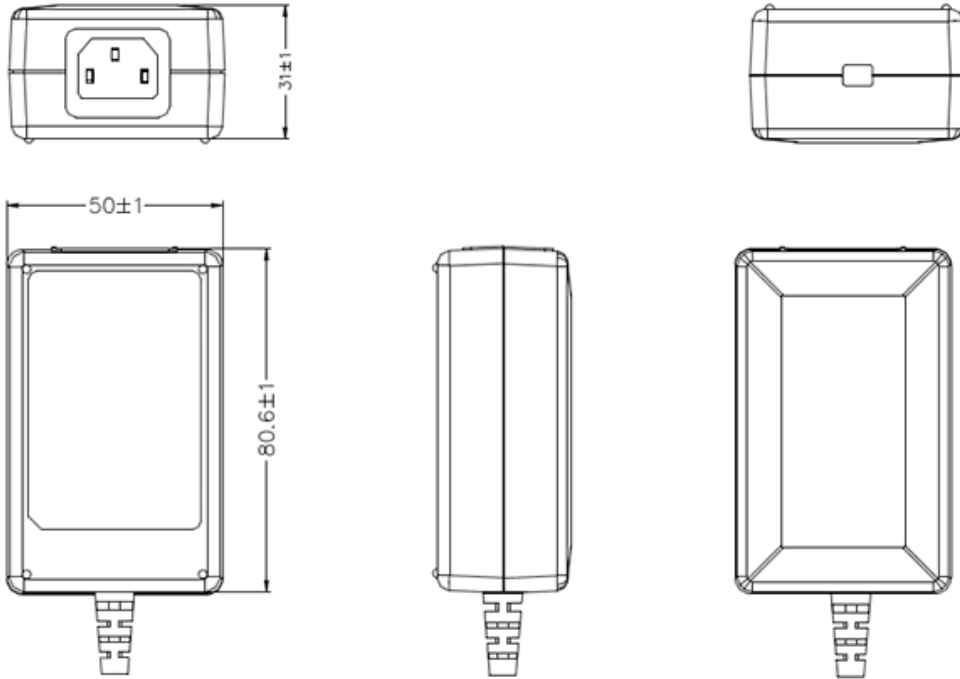

Delivering leading edge, innovative power solutions for more than **30** years....

Model:GT-46240-24VV-x.x-T3

June 1, 2020

RATING TABLE

Model Number	Voltage	Amps(A)	Watts(W)	RFQ
GT-46240-2412-T3	12 V	2	24.00	RFQ
GT-46240-2415-T3	15 V	1.6	24.00	RFQ
GT-46240-2424-6.0-T3	18 V	1.33	23.94	RFQ
GT-46240-1824-6.0-T3	18 V	1	18.00	RFQ
GT-46240-2424-5.0-T3	19 V	1.26	23.94	RFQ
GT-46240-1824-T3	24 V	0.75	18.00	RFQ
GT-46240-2424-T3	24 V	1	24.00	RFQ

Model:GT-46240-24VV-x.x-T3

June 1, 2020

SPECIFICATIONS

A) ELECTRICAL SPECIFICATIONS:

01. Input Voltage: Specified 90-264 Vac, Nameplate rated: 100-240Vac
02. Input Frequency: Specified 47-63 Hz, Nameplate rated 50-60Hz
03. Inrush Current: 50A Max. at 115VAC cold start, 100A Max. at 230VAC cold start
04. Average Efficiency: 86.2% Min (CEC & DOE LEVEL VI Compliant); 86.8% Min (ErP European Commission's Ecodesign Directive (2005/32/EC) / CoC Tier 2 Compliant)
05. Input Power(no load): <0.1W (CEC & DOE Level VI Compliant); <0.075W ErP European Commission's Ecodesign Directive (2005/32/EC) / CoC Tier 2 Compliant)
06. Output Voltage tolerance: $\pm 5\%$
07. Load regulation: $\pm 5\%$
08. Output Voltage: Tolerance $\pm 5\%$
09. Turn On Delay: 3000 mS MAX at 115 VAC Full Load
10. Hold Up Time: 10 mS Min at 100 VAC Full Load
11. Ripple and Noise (Vp-p): 100 mVp-p maximum, At 20 MHz, and output parallel with 0.1uF & 47uF capacitors to ground. Temperature at 25 °C, and nominal input voltage

B) PROTECTION

01. Over voltage protection: protection zener
02. Short circuit protection: Output shut down and auto- recover
03. Over Load Protection: Output shut down and auto restart

C) SAFETY

01. HI-POT : Input to output : 1500VAC or 2121VDC 10mA 1 minute
02. Earth Leakage Current: <3.5 mA at 240Vac input voltage
03. Insulation resistance: Input to output: 500vdc to test the input to output resistance not be less 100M ohm
04. Earth continuity test:<0.1 Ohm or < 0.2 Ohm when with a non-detachable Power Supply cord, Class I Only

D) OTHER:

01. MTBF: 200,000 Hours @ 25°C ambient temperature
02. Operating Temperature: 0°C to 40°C ambient temperature
03. Humidity Operating : 20% to 80%. 0% to 90% relative humidity
04. Storage Temperature: -10°C to 70°C
Humidity Storage: 10% to 90%
05. RoHS 2: Complies with EU 2011/65/EU and China SJ/T 11364-2014

E) ENCLOSURE

01. Housing: High impact plastic, 94V0 polycarbonate, non-vented
02. Size: 80.6*50.0*31.0 +/-1.0 mm
03. Markings: Label and/or Pad Printed and/or Molded in the case

Delivering leading edge, innovative power solutions for more than 30 years....

Model:GT-46240-24VV-x.x-T3

June 1, 2020

DERATING CURVE

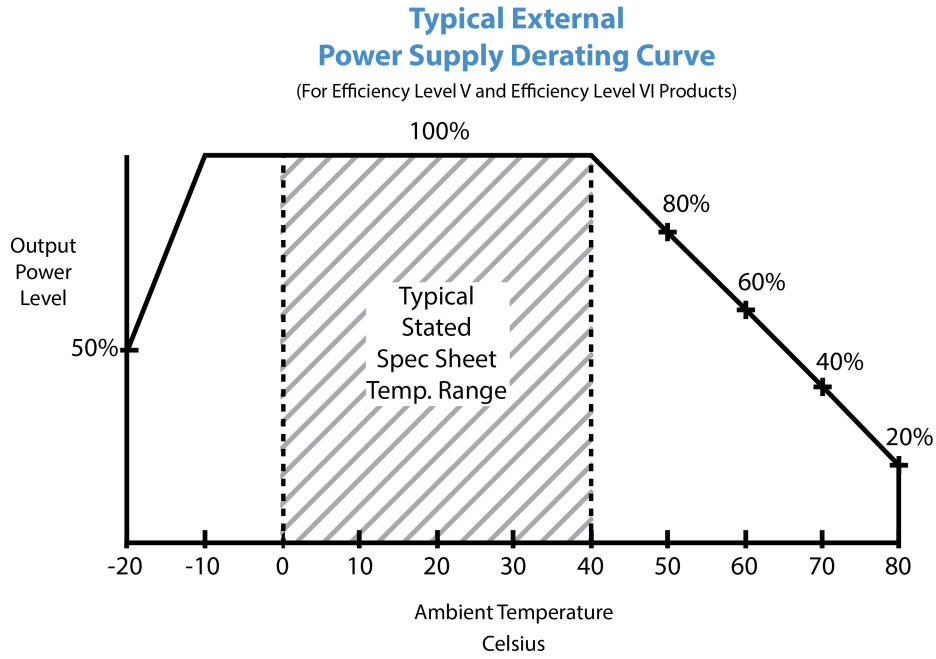

Delivering leading edge, innovative power solutions for more than 30 years....

Model:GT-46240-24VV-x.x-T3

June 1, 2020

INPUT CONFIGURATION

Description IEC 60320/C14 AC Inlet Connector, Class I, Earth Ground

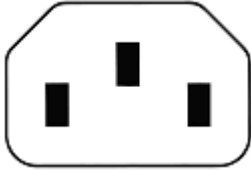

Mates with IEC 60320/C13 Plug

Optional Locking IEC60320 Receptacle and cord option available on some models by request.:

[Standard International IEC 320/C13 Cordsets](#)

Below are standard cordsets which are "not included" (unless stated above); these can be purchased separately or packaged with the power supply. Contact your Sales Engineer if the style required is not shown below. Many more available in different lengths, colors or cable material.

Stock Power Supply Cords

Part Number/ Link	Country	Plug	Termination	Length (mm)	(Ft)
3021457F701(R)	N. American (Type B)	NEMA 5-15P	IEC 320/C13	2150	7
1191068F0701(R)	N. American (Type B)	NEMA 5-15P Hospital	IEC 320/C13	2459	8
2194272M5701-T(R)	Argentina (Type I)	IRAM 2073	IEC 320/C13	2500	8
5502022M5701A(R)	Australian (Type I)	AS3112 / 3 PRONG	IEC 320/C13	2500	8
204B4272M5701(R)	Brazil (Type N)	BRAZIL	IEC 320/C13	2500	8
6023602M5701(R)	China (Type I)	CCC GR2099	IEC 320/C13	2500	8
G8014272M5701(R)	Danish (Type K)	AFSNIT SECTION 107-2-D1	IEC 320/C13	2500	8
23144272M5701-T(R)	Europe (Type E)	CEE 7/7	IEC 320/C13	2500	8
205IN4272M5701(R)	India (Type D)	India IS 1293 (also known as IA16A3 or BS546)	IEC 320/C13	2500	8
208IN4272M5701(R)	India (Type M)	India IS 1293 (also known as IA16A3 or BS546)	IEC320/C13	2500	8
377C4272M5701(R)	Israel (Type H)	ISL 377C	IEC 320/C13	2500	8
23024272M5701(R)	Italy (Type L)	CEI 23-16/VII	IEC 320/C13	2500	8
3003339F701(R) [3x1.25mm2]	Japan (Type B)	JIS 8303 / 3 PINS	IEC 320/C13	2500	8

PROPRIETARY INFORMATION

PROPRIETARY OF GLOBTEK, INC. ANY REPRODUCTION, DISCLOSURE OR USE OF THIS DRAWING, IN WHOLE OR IN PART, IS HEREBY PROHIBITED EXCEPT AS SPECIFIED IN WRITING BY GLOBTEK, INC.

<http://en.globtek.com/datasheet/id/a00a000000MjLiq>

Delivering leading edge, innovative power solutions for more than **30** years....

Model:GT-46240-24VV-x.x-T3

June 1, 2020

3003068F2701-HK(R) [3 x 2.0mm2]					
302J115J6F0701J(R)	Japan / North America (Type B – 12A)	JIS 8303 / 3 PINS and NEMA 5-15P (PSE and UL/CUL appr)	IEC 320/C13	1830	6
302J104J6F0701J(R)	Japan / North America (Type B – 15A)	JIS 8303 / 3 PINS and NEMA 5-15P (PSE and UL/CUL appr)	IEC 320/C13	1830	6
2313K3432M5701(R)	Korea (Type F)	KS C 8305	IEC 320/C13	2500	8
5804272M5701(R)	Russia (Type F)	GOST 7396	IEC 320/C13	2500	8
2084272M5701(R)	South Africa (Type M)	South Africa SABS164-1 (16A type)	IEC 320/C13	2500	8
23214272M5701(R)	Switzerland (Type J)	SEV 1011	IEC 320/C13	2500	8
3003322M5701(R)	Taiwan (Type B)	BSMI	IEC 320/C13	2500	8
PZ0800100-2M5BK13H(R)	UK, Hong Kong, Singapore, Gulf States (Type G)	BS 1363A	IEC 320/C13	2500	8
7055002M5701A(R)	International	IEC 320 C14-C13	IEC 320/C13	2500	8

Delivering leading edge, innovative power solutions for more than 30 years....

Model:GT-46240-24VV-x.x-T3

June 1, 2020

OUTPUT CONFIGURATION

Common output connector options:

 L Type (Coaxial
5.5x2.5mm plug)

 C Type (Coaxial
5.5x2.1mm plug)

 K Type (Coaxial
3.5x1.3mm plug)

 LL Type (5.5x2.5mm
Locking 760k type)

 CL Type (5.5x2.1mm
Locking S761k type)

 ML2 Type (Molex
housing 43025-0200)

 YL3 Type
(KPPX-3P)

YL4 Type (KPPX-4P)

 EJ1/2/3/4/5 (EIAJ
RC-5320A type
connectors)

 MSB Type (Micro
USB)

 USBC Type (USB
Type C)

 Inquire for custom
design

 For a comprehensive list of options, [click here](#)

Contact GlobTek for your specific requirements or custom solutions.

Delivering leading edge, innovative power solutions for more than 30 years....

Model:GT-46240-24VV-x.x-T3

June 1, 2020





Approvals

Logo	Description
No Logo Applicable	EU 230V CoC Tier 2, 278/2009, Mar 2014
No Logo Applicable	CB for IEC 62368-1:2014 (Second Edition)
 2000	CCC to GB4943.1-2011 GB9254-2008 GB17625.1-2012
	CE Mark: tested to comply with EN55022:2006/A1:2007 Class B, EN610003-2, EN610003-3 including EN61000-4-2, EN61000-4-3, EN61000-4-4, EN61000-4-5, EN61000-4-6N EN61000-4-11; EMI: Complies with EN55011 CLASS B and FCC Part 15B - On label or Molded in case
	CHINA SJ/T 11364-2014, China RoHS Chart: http://en.globtek.com/globtek-rohs.php
	UL 60950-1, 2nd Edition, 2014-10-14 (Information Technology Equipment - Safety - Part 1: eneral Requirements) CAN/CSA C22.2 No. 60950-1-07, 2nd Edition, 2014-10 (Information Technology Equipment - Safety - Part 1: General Requirements)
	Declaration ДС № EAЭC N RU Д-US.KA01.B.10453_19 Custom Union of Russia, Belarus and Kazakhstan http://www.globtek.com/redirect/?loc=gost-certificate-eac-declaration
CAN ICES-3(B)/NMB-3(B)	Compliance of this PSU with Industry Canada, Class B demonstrated with a standard output load. The ICES law stipulates that system-level testing is required to demonstrate compliance with the ICES-3 emission limits with the actual system load.

Delivering leading edge, innovative power solutions for more than 30 years....

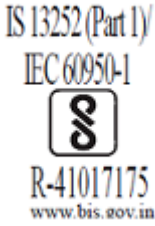
Model:GT-46240-24VV-x.x-T3

June 1, 2020

	<p>Bureau Of Indian Standards for GT-46240-T3/T3A) (12V, 15V, 18V, 19V, 24V only)</p>
	<p>Indoor Use Only - Mark is on the label or Molded in the case</p>
<p>IP52</p>	<p>Ingress Protection: ?IP52 to IEC60529:2001 Protected against dust - limited ingress (no harmful deposit) and Protected against direct sprays up to 15 degrees from the vertical (with R-Blades)</p>
	<p>Korea KET KC Mark GT-46240-24xx-T3 HU10499-16028A (24V, 20V and 18V Only)</p>
<p>EFFICIENCY LEVEL </p>	<p>Efficiency: complies to section 301 of Energy Independence and Security Act (EISA) complies with Energy Star tier 2 (North America), ECP tier 2 (China), MEPS tier 2 (Australia), Code of Conduct (Europe)</p>
<p>LPS</p>	<p>Limited Power Source 60950</p>

Delivering leading edge, innovative power solutions for more than 30 years....

Model:GT-46240-24VV-x.x-T3

June 1, 2020

	Morocco SDoC declaration http://www.globtek.info/certs/Morocco%20SDoC%20Declaration/
 GlobTek, Inc.	JAPAN TUV Rheinland-PSE GlobTek Inc to J60950-1(H26) , J55022(H22),J3000(H25).Please follow the procedure listed in the following link for proper import to Japan: http://en.globtek.com/importing-to-japan.php .
 N136 SAA-160907-EA	RCM certificate SAA-160907-EA; Australia and New Zealand Regulatory Compliance, Mark (http://rcm.standards.org.au/rcmfaq/rcmfaq.htm)
RoHS	Specifications of directive 2011/65/EU Annex VI (ROHS-2) with amendment 2015/863-EU (ROHS-3) http://www.ce-mark.com/Rohs%20final.pdf
 Intertek	S-Mark Certificate EN 60950-1:2006 + A11:2009 + A1:2010 + A12:2011 +A2:2013 (http://www.intertek.com/marks/s/)
 10276	Ukraine UKRSepto (Document: www.globtek.com/html/iso_certificates/GT_Ukraine.pdf)
	Japan: Voluntary Control Council for Interference (VCCI)
	WEEE: Complies with EU 2012/19/EU (http://ec.europa.eu/environment/waste/weee/index_en.htm) Mark is on the label or Molded in the case