

Delivering leading edge, innovative power solutions for more than 30 years....

Model:GT-46400-40VV-X.X-T2

November 30, 2021

DOE EPS 2.0 Level VI Power Supply / Charger / AC Adapter, 40W Desktop/Tabletop with Class II Input, Available with 12-24VDC output Certified to Medical and ITE Standards

Information

Model Number	GT-46400-40VV-X.X-T2
Description	40 W, DoE Level VI & CoC Tier 2 Efficiency, Two Prong (C8) Inlet, Desktop Adapter, Ac-Dc Power Supply

Model Picture

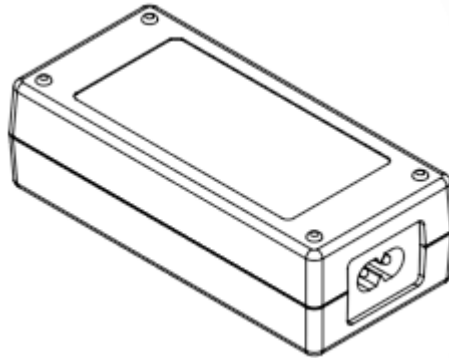

Agency Documents	http://www.globtek.info/certs/GT-46400-WVVV-X.X-TZ/
CE EC-Declaration	https://www.globtek.com/pdf/ec_declaration/a00a000000Mih2SEAR
RoHS/RoHS2 Declaration	https://www.globtek.com/pdf/rohs_cert/a00a000000Mih2SEAR
REACH Declaration	https://www.globtek.com/pdf/iso_certificates/REACH.pdf
Conflict Minerals Declaration	https://www.globtek.com/pdf/conflict-minerals.pdf

Delivering leading edge, innovative power solutions for more than **30** years....

Model:GT-46400-40VV-X.X-T2

November 30, 2021

MODEL PARAMETERS

Type	Desktop/External
Technology	Regulated Switchmode AC-DC Power Supply AC Adaptor
Category	ICT/ITE Power Supply
Input Voltage	100-240V~, 50-60 Hz
I/P Amps (A)	1.0A
Wattage (W)	40.0
Vout Range (V)	12-24
Efficiency Level	USA DOE Level VI / Eco-design Directive 2009/125/EC, (EU) 2019/1782
Ingress Protection	Indoor Use
Size (mm)	111*52*32.3

Delivering leading edge, innovative power solutions for more than 30 years....

Model:GT-46400-40VV-X.X-T2

November 30, 2021

ENCLOSURE

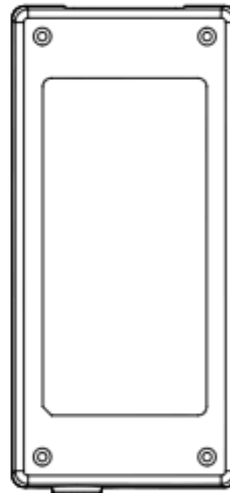
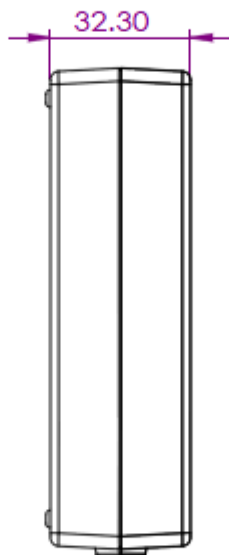
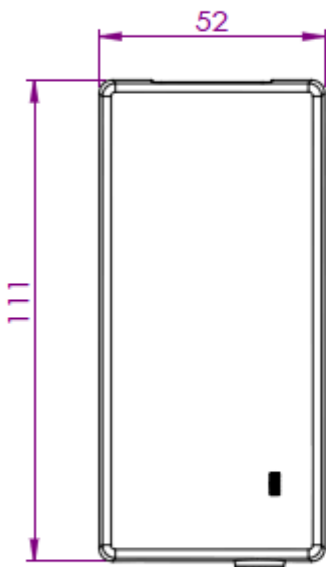
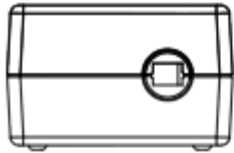

Delivering leading edge, innovative power solutions for more than 30 years....

Model:GT-46400-40VV-X.X-T2

November 30, 2021

RATING TABLE

Model Number	Voltage	Amps(A)	Watts(W)	RFQ
GT-46400-3612-T2	12 V	3	36.00	RFQ
GT-46400-3615-2.0-T2	13 V	2.76	35.88	RFQ
GT-46400-3615-1.0-T2	14 V	2.57	35.98	RFQ
GT-46400-3315-0.5-T2	14.5 V	2.27	32.92	RFQ
GT-46400-4015-T2	15 V	2.66	39.90	RFQ
GT-46400-4019-3.0-T2	16 V	2.5	40.00	RFQ
GT-46400-4019-2.0-T2	17 V	2.35	39.95	RFQ
GT-46400-4019-1.0-T2	18 V	2.22	39.96	RFQ
GT-46400-4019-T2	19 V	2.1	39.90	RFQ
GT-46400-4024-4.0-T2	20 V	2	40.00	RFQ
GT-46400-4024-3.0-T2	21 V	1.9	39.90	RFQ
GT-46400-4024-2.0-T2	22 V	1.81	39.82	RFQ
GT-46400-4024-1.0-T2	23 V	1.73	39.79	RFQ
GT-46400-4024-T2	24 V	1.66	39.84	RFQ
GT-46400-4048-T2	48 V	0.83	39.84	RFQ

Model:GT-46400-40VV-X.X-T2

November 30, 2021

SPECIFICATIONS

A) ELECTRICAL SPECIFICATIONS:

01. Input Voltage: Specified 90-264 Vac, Nameplate rated: 100-240Vac
 02. Input Frequency: Specified 47-63 Hz, Nameplate rated 50-60Hz
 03. Inrush Current: NO Damage
 04. Efficiency: Compliant with Efficiency Level VI and CoC Tier 2 standards
 05. No Load Standby Power: <0.075W @ 230Vac
 06. Load regulation: $\pm 5\%$
 07. Output Voltage: Tolerance $\pm 5\%$
 08. Ripple Voltage: 120mV (p-p): Input :(100V-240VAC), Output:full load
- Ripple&Noise test: Use 20MHz band width frequency oscilloscope.Add 0.1uF/47uF Capacitor output connector terminal

B) PROTECTION

01. Over voltage protection: $\leq 16V$
02. Short circuit protection: Output shut down and auto- recover
03. Over Load Protection: $\leq 5A$ output load

C) SAFETY

01. HI-POT : Input to output : 3000VAC 10mA 1 minute (for Class II), 1500VAC 10mA 1 minute(for Class I)
02. Insulation resistance: Input to output: 500vdc to test the input to output resistance not be less 100M ohm
03. Touch Current: <0.25mA @ 240Vac input voltage

D) OTHER:

01. MTBF: 200,000 Hours @ 25°C ambient temperature
 02. Operating Temperature: 0°C to 40°C ambient temperature
 03. Humidity Operating : 20% to 80%. 0% to 90% relative humidity
 04. Storage Temperature: -10°C to 70°C
- Humidity Storage: 10% to 90%
05. RoHS 2: Complies with EU 2011/65/EU andChina SJ/T 11364-2014

E) ENCLOSURE

01. Housing: High impact plastic, 94V0 polycarbonate, non-vented
02. Size: 111.0 x 52.0 x 32.3 +/-1.0 mm
03. Markings: Label and/or Pad Printed and/or Molded in the case

Delivering leading edge, innovative power solutions for more than 30 years....

Model:GT-46400-40VV-X.X-T2

November 30, 2021

DERATING CURVE

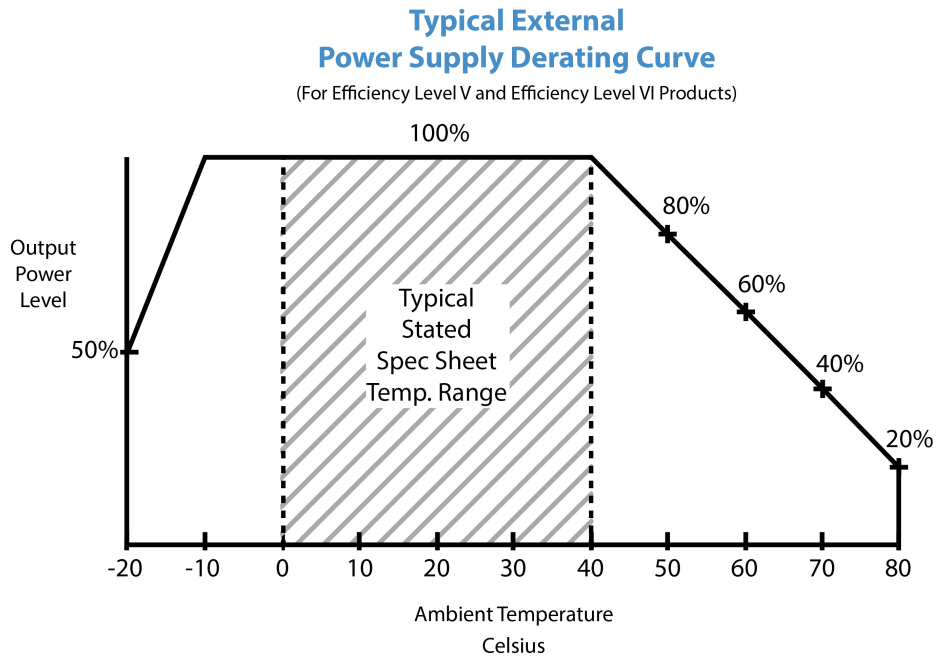

Delivering leading edge, innovative power solutions for more than 30 years....

Model:GT-46400-40VV-X.X-T2

November 30, 2021

INPUT CONFIGURATION

Description IEC 60320/C8 AC Inlet connector, Class II, Non-Earth Ground (aka "Figure-8")

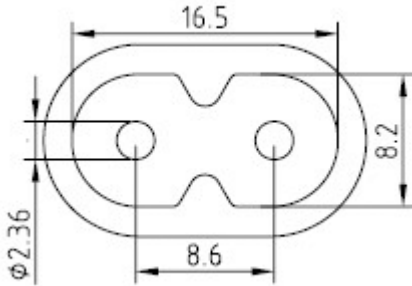

Mates with IEC 60320/C7 Plug

Below are standard cordsets which are "not included" (unless stated above); these may be purchased separately or packaged with the power supply. Please contact your Sales Engineer if the style required is not shown below. Many more available in different lengths, colors or cable material.

Standard International IEC 320/C7 Cordsets

Part Number	Type	Standard	Connector	Length (mm)	Length (feet)
2094112M703(R)	Argentina (Type I)	IRAM 2063	IEC 320/C7	2000	7
5014112M703A(R)	Australian (Type I)	AS 3112	IEC 320/C7	2000	7
207B4111M8703(R)	Brazil (Type N)	NBR14136	IEC 320/C7	1800	6
4533501M8703(R)	China (Type A)	GB 2099.1	IEC 320/C7	1830	6
2074112M703A(R)	European (Type C)	CEE 7/16	IEC 320/C7	2000	7
2084111M8703B(R)	India (Type D)	IS 1293	IEC 320/C7	1800	6
451J3401M8703(R)	Japan (Type A)	JIS 8303	IEC 320/C7	1830	6
2044112M703A(R)	Korea (Type C)	KS C8305	IEC 320/C7	2000	7
4511116F703A(R)	North America (Type A)	NEMA 1-15P	IEC 320/C7	1830	6
	South Africa (Type				

Delivering leading edge, innovative power solutions for more than **30** years....

Model:GT-46400-40VV-X.X-T2

November 30, 2021

2084111M8703(R)	M)	BS 546	IEC320/C7	1830	6
4033401M8703A(R)	Taiwan (Type A)	CNS690	IEC 320/C7	1830	6
6104112M703A(R)	UK, Hong Kong, Singapore, Gulf States (Type G)	BS1363	IEC 320/C7	2000	7
451G1116F703A(R)	Gulf States (Kuwait, Bahrain, Oman, Qatar, Saudi Arabia, Yemen and the United Arab Emirates (UAE)(Type A)	Nema 1-15P	IEC320/C7	1830	6

Delivering leading edge, innovative power solutions for more than 30 years....

Model:GT-46400-40VV-X.X-T2

November 30, 2021

OUTPUT CONFIGURATION

Common output connector options:

 L Type (Coaxial
5.5x2.5mm plug)

 C Type (Coaxial
5.5x2.1mm plug)

 K Type (Coaxial
3.5x1.3mm plug)

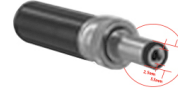
 LL Type (5.5x2.5mm
Locking 760k type)

 CL Type (5.5x2.1mm
Locking S761k type)

 ML2 Type (Molex
housing 43025-0200)

 YL3 Type
(KPPX-3P)

YL4 Type (KPPX-4P)

 EJ1/2/3/4/5 (EIAJ
RC-5320A type
connectors)

 MSB Type (Micro
USB)

 USBC Type (USB
Type C)

 Inquire for custom
design

 For a comprehensive list of options, [click here](#)





Contact GlobTek for your specific requirements or custom solutions.

Delivering leading edge, innovative power solutions for more than **30** years....

Model:GT-46400-40VV-X.X-T2

November 30, 2021







Approvals

Logo	Description
No Logo Applicable	EU 230V CoC Tier 2, 278/2009, Mar 2014
No Logo	IEC 60950-1: 2005 (Second Edition) + Am 1: 2009 + Am 2: 2013
No Logo Applicable	CB for IEC 62368-1:2014 (Second Edition)
	CE Mark: tested to comply with EN55022:2006/A1:2007 Class B, EN610003-2, EN610003-3 including EN61000-4-2, EN61000-4-3, EN61000-4-4, EN61000-4-5, EN61000-4-6N EN61000-4-11; EMI: Complies with EN55011 CLASS B and FCC Part 15B - On label or Molded in case
	CHINA SJ/T 11364-2014, China RoHS Chart: http://en.globtek.com/globtek-rohs.php
Conforms to UL STD. 62368-1 Certified to CSA STD C22.2 NO.62368-1	Conforms to UL STD. 62368-1 Certified to CSA STD C22.2 NO.62368-1
	UL60950-1, cULus to UL 60950-1 E170507
	
	Declaration ДС № EAЭC N RU Д-US.KA01.B.10453_19 Custom Union of Russia, Belarus and Kazakhstan http://www.globtek.com/redirect/?loc=gost-certificate-eac-declaration
	Compliance of this power supply with FCC Part 15, Class B has been demonstrated with a standard output load. The FCC law stipulates that system-level testing is required to demonstrate compliance with the FCC emission limits with the actual system load.
CAN ICES-3(B)/NMB-3(B)	Compliance of this PSU with Industry Canada, Class B demonstrated with a standard output load. The ICES law stipulates that system-level testing is required to demonstrate compliance with the ICES-3 emission limits with the actual system load.

Delivering leading edge, innovative power solutions for more than 30 years....

Model:GT-46400-40VV-X.X-T2





November 30, 2021

	Indoor Use Only - Mark is on the label or Molded in the case
IP40	Ingress Protection: ?IP40 to IEC60529:2001 Protection against granular foreign bodies (with I/P cord)
 GlobTek, Inc.	JAPAN TUV R-PSE, Cert. No. JD 50473430, to J62368-1(H30) , J55032(H29),J3000(H25)[15V or less]. Please reference the following website for guidelines on PSE regulations: http://en.globtek.com/importing-ite-and-medical-power-supplies-ac-adaptors-to-japan/
EFFICIENCY LEVEL 	Efficiency: complies to section 301 of Energy Independence and Security Act (EISA) complies with Energy Star tier 2 (North America), ECP tier 2 (China), MEPS tier 2 (Australia), Code of Conduct (Europe)
LPS	Limited Power Source 60950
	Morocco SDoC declaration http://www.globtek.info/certs/Morocco%20SDoC%20Declaration/
	NOM (Mexico) to NOM-001-SCFI-1993 GT-46400-3612-T2
 GlobTek, Inc.	JAPAN TUV Rheinland-PSE GlobTek Inc to J60950-1(H26) , J55022(H22),J3000(H25).Please follow the procedure listed in the following link for proper import to Japan: http://en.globtek.com/importing-to-japan.php .
RoHS	Specifications of directive 2011/65/EU Annex VI (ROHS-2) with amendment 2015/863-EU (ROHS-3) http://www.ce-mark.com/Rohs%20final.pdf
	SIQ Mark EN 62368-1:2014 + All:2017
	UKCA Certification

Delivering leading edge, innovative power solutions for more than **30** years....

Model:GT-46400-40VV-X.X-T2

November 30, 2021

 10276	Ukraine UKRSeprO (Document: www.globtek.com/html/iso_certificates/GT_Ukraine.pdf)
	UL 62368-1 and CAN/CSA C22.2 No. 62368-1-14
	Japan: Voluntary Control Council for Interference (VCCI)
	WEEE: Complies with EU 2012/19/EU (http://ec.europa.eu/environment/waste/weee/index_en.htm) Mark is on the label or Molded in the case