

Delivering leading edge, innovative power solutions for more than 30 years....

Model:GTM46101-WWVV-X.X-USB

June 6, 2020

## 60601-1 Medical DOE EPS 2.0 Level VI Power Supply / Charger, 5v, 2.0A, with integral USB Jack, compliant with 2MOPP, 5000 Meters Elevation and 8 kV Contact/20kV Air Discharge ESD Protection

### Information

**Model Number**

GTM46101-WWVV-X.X-USB

**Description**

GTM46101-WWVV-X.X-USB, ITE / Medical Power Supply, 60601-1-4th Ed. , Wall Plug-in, Regulated Switchmode AC-DC Power Supply AC Adaptor, , Input Rating: 100-240V~, 50-60 Hz, Blade Options for Q Series Wall Plug-in Power Supplies, Output Rating: 10 Watts, Power rating with convection cooling (W) , 5-5.2V in 0.1V increments, Approvals: South Africa; EAC; ETL 62368; Morocco; Korea (5V-5.4V Only); CAN ICES-3; FCC; CE; CB 60601-1 2MOPP; CB 60950; CE; cETLus ES60601; cETLus 60601-1 3rd; China RoHS; Double Insulation; IP20; Level VI; LPS 60950; CB 62368; RoHS; S-Mark IEC/EN 60601-1; Ukraine;cETLus 60950; RCM; CCC; India (5V only); CB EN/IEC 60335-1; PSE;

**Model Picture**

**Agency Documents**
<http://www.globtek.info/certs/GTM46101-10VV-X.X/>
**CE EC-Declaration**
[https://www.globtek.com/pdf/ec\\_declaration/a0Oa000000MEtdeEAD](https://www.globtek.com/pdf/ec_declaration/a0Oa000000MEtdeEAD)
**RoHS/RoHS2 Declaration**
[https://www.globtek.com/pdf/rohs\\_cert/a0Oa000000MEtdeEAD](https://www.globtek.com/pdf/rohs_cert/a0Oa000000MEtdeEAD)
**REACH Declaration**
[https://www.globtek.com/pdf/iso\\_certificates/REACH.pdf](https://www.globtek.com/pdf/iso_certificates/REACH.pdf)
**Conflict Minerals Declaration**
<https://www.globtek.com/pdf/conflict-minerals.pdf>

Delivering leading edge, innovative power solutions for more than **30** years....

Model:GTM46101-WWVV-X.X-USB

June 6, 2020

**MODEL PARAMETERS**

Type	Wall Plug-in
Technology	Regulated Switchmode AC-DC Power Supply AC Adaptor
Category	ITE / Medical Power Supply
Input Voltage	100-240V~, 50-60 Hz
I/P Amps (A)	0.3A
Wattage (W)	10.0
Vout Range (V)	5-5.2
Efficiency Level	USA DOE Level VI / Eco-design Directive 2009/125/EC, (EU) 2019/1782
Ingress Protection	Indoor Use
Size (mm)	41.0 x 71.0 x 31.5

Delivering leading edge, innovative power solutions for more than 30 years....

Model:GTM46101-WWVV-X.X-USB

June 6, 2020

# ENCLOSURE

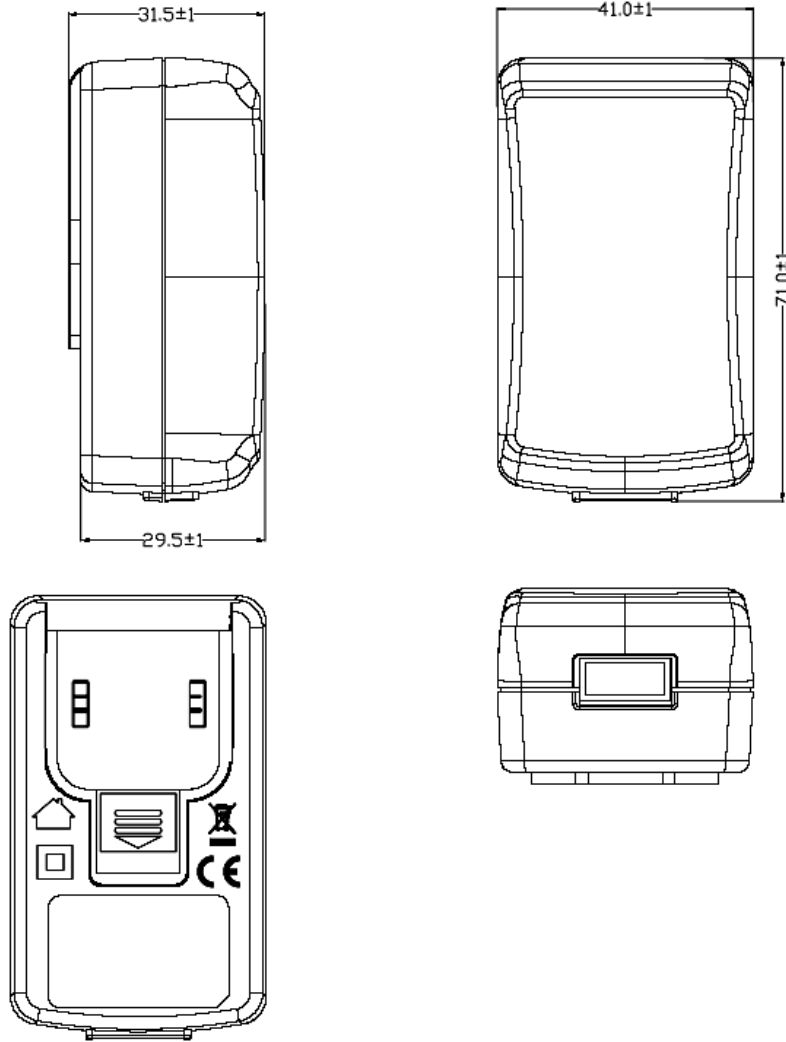

Delivering leading edge, innovative power solutions for more than **30** years....

Model:GTM46101-WWVV-X.X-USB

June 6, 2020

**RATING TABLE**

Model Number	Voltage	Amps(A)	Watts(W)	RFQ
GTM46101-1005-USB	5 V	2	10.00	<a href="#">RFQ</a>
GTM46101-1306-0.9-USB	5.1 V	2.54	12.95	<a href="#">RFQ</a>
GTM46101-1306-0.8-USB	5.2 V	2.5	13.00	<a href="#">RFQ</a>

## SPECIFICATIONS

### A) ELECTRICAL SPECIFICATIONS:

1. Input Voltage: Specified 90-264 Vac, Nameplate rated 100-240 Vac
2. Input Frequency: Specified 47-63 Hz, Nameplate rated 50-60 Hz
3. Output Regulation: +/- 5% measured at the end of a 1.2 meter USB cordset employing #20 Gauge conductors (RFP RFI-50856)  
The longest cable GlobTek recommends to be used with this product is USB cord GlobTek PN USBA1M2MICROB20(R), 1.2 Meters for best voltage regulation performance. (RFP RFI-20435-3)
4. Line Voltage Regulation: +/- 3% typical measured at the end of a 1.2 meter USB cordset employing #20 Gauge conductors
5. Output Ripple (Vp-p): 150mV Ripples shall be measured with a 47uF electrolytic capacitor paralleled with a high-frequency 0.1uF ceramic capacitor across the output. The oscilloscope's bandwidth shall be set to 20MHz.
6. Turn-On/Turn-Off Overshoot: 5% maximum, 500 us maximum recovery time for 25% step load.
7. Turn-On Delay: 3000mS MAX at 115VAC Full Load
8. Hold-Up Time: 8mS Min at 100VAC Full Load
9. Inrush Current: No damage. On power when switching on/off repeatedly under any condition.
10. Switching Frequency: 66.5 KHz typical
11. Average Efficiency: 78.7% Min.(CEC&DOE Level VI Compliant), 79.0% Min. (ErP European Commission's Ecodesign Directive (2005/32/EC) / CoC Tier 2 Compliant)
12. Input Power(no load): < 0.1W < 0.1W, < 0.075W (ErP European Commission's Ecodesign Directive (2005/32/EC) / CoC Tier 2 Compliant)
13. Cable voltage drop compensation circuitry

### B) PROTECTION

1. Over-Voltage: Output shut down and auto restart 110% to 140% of Vnom
2. Over Temperature Protection: Output shut down and auto restart
3. Short Circuit Protection Output shut down and auto restart
- 4 Over Load Protection Output shut down and auto restart 110% to 150% of Inom
5. Input Protection: Input line fusing
6. ESD: 8 kV Contact/20kV Air Discharge

### C) SAFETY

1. Dielectric Withstand Voltage: 4000Vac or 5656Vdc 10mA 1 minute
2. Earth Leakage Current: N/A for Class II units, there is no PE Ground pin, so Earth Leakage current is not measured
3. Touch Current: Maximum allowed values: 100uA NC(Normal condition) 500uA SFC(single fault condition)
4. Means of Protection: 2 x MOPP
5. ROHS 2: Complies with EU 2011/65/EU and China SJ/T 11363-2006

### D) EMC

1. Emissions, per EN 55032, EN 61000-6-3, EN 61000-6-4  
Conducted Emissions: Class B, FCC Part 15, Class B  
Radiated Emissions: Class B, FCC Part 15, Class B
2. Line Frequency Harmonics EN61000-3-2, Class A
3. Voltage Fluctuations/Flicker EN61000-3-3
4. Immunity, per EN 55024, EN 61000-6-1, EN 61000-6-2  
Static Discharge Immunity EN61000-4-2, 8kV Contact Discharge, 15kV air discharge  
Radiated RF Immunity EN61000-4-3, 3V/m 80-2700MHz, 80% 1KHz AM.  
EFT/Burst Immunity EN61000-4-4, 2kV/100kHz.

### PROPRIETARY INFORMATION

PROPRIETARY OF GLOBTEK, INC. ANY REPRODUCTION, DISCLOSURE OR USE OF THIS DRAWING, IN WHOLE OR IN PART, IS HEREBY PROHIBITED EXCEPT AS SPECIFIED IN WRITING BY GLOBTEK, INC.

<http://en.globtek.com/datasheet/id/a0Oa000000MEtde>

Delivering leading edge, innovative power solutions for more than **30** years....

Model:GTM46101-WVVV-X.X-USB

June 6, 2020

Line Surge Immunity EN61000-4-5, 1kV differential, 2kV common-mode  
Conducted RF Immunity EN61000-4-6, 3Vrms, 80% 1KHz AM  
Power Frequency Magnetic Field Immunity EN61000-4-8, NA  
Voltage Dip Immunity EN61000-4-11, Criteria

## E) OTHER:

1. MTBF: 200,000 hours @ 25°C ambient temperature
2. Operating Temperature: 0°C to 40°C ambient temperature
3. Humidity: 0% to 95% relative humidity
4. Storage Temperature: -40°C to 80°C

## F) ENCLOSURE

1. Housing: High impact plastic, 94V0 polycarbonate, non-vented
2. Markings: Label and/or Pad Printed and/or Molded in the case

Delivering leading edge, innovative power solutions for more than 30 years....

Model:GTM46101-WWVV-X.X-USB

June 6, 2020

## DERATING CURVE

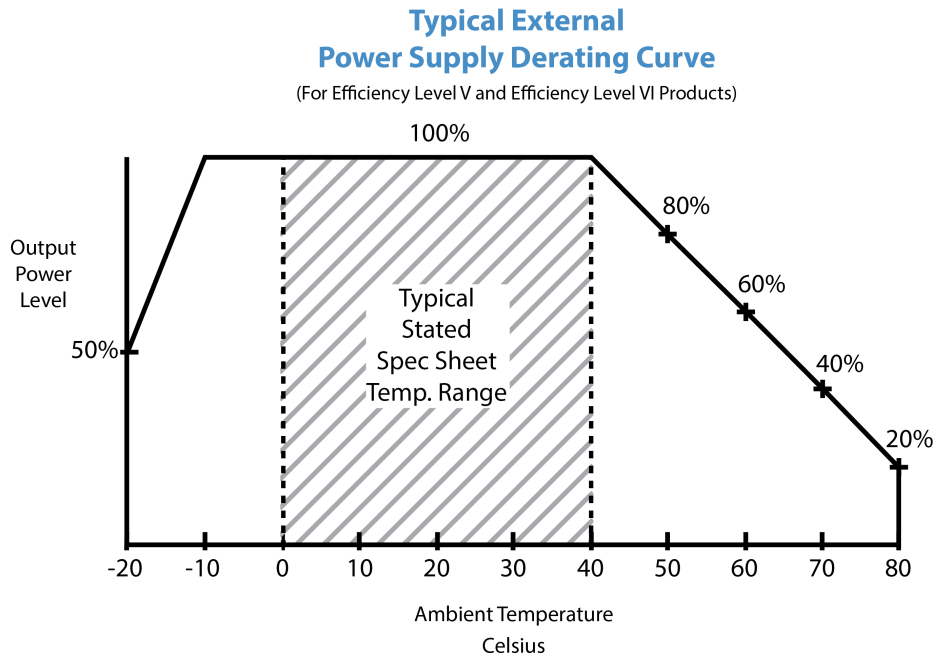

Delivering leading edge, innovative power solutions for more than 30 years....

Model:GTM46101-WWVV-X.X-USB

June 6, 2020

## INPUT CONFIGURATION

Description Blade Options for Q Series Wall Plug-in Power Supplies

Data Sheet: <http://en.globtek.com/interchangeable-blades.php>

Insertion Instructions: <http://www.globtek.com/pdf/Instructions-Interchangeable-Blades.pdf>

Video: [Q-Blade Style Instruction Video](#)

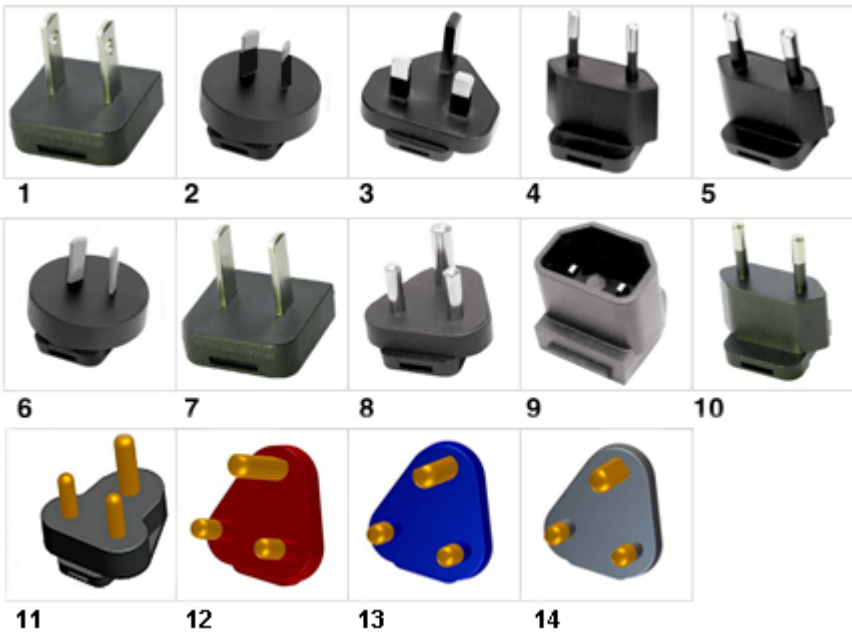

INPUT CONNECTOR: Q-Socket (below are available blades configurations which are "not included" (unless stated above); can be purchased separately, package with power supply or as a separate "Q-KIT" if specified

01. United States / Canada / Japan NEMA 1-15P/IEC PLUG A[WORKS IN PLUG B] configuration: NA 2 blades, Class II; US/CA/JP P/N: Q-NA(R)
02. Australian AS 3112 configuration: SAA 2 blade/IEC TYPE I, Class II; AU P/N: Q-SAA(R)
03. UK BS 1363 configuration: UK 3 blade with dummy Ground/IEC TYPE G, Class II; GB P/N: Q-UK(R)
04. European CEE 7/16 configuration: Europlug 2 pins/IEC TYPE C [WORKS IN TYPE E&F], Class II; EU P/N: Q-EU(R)
05. Korean KS C8305 configuration: 2 pins/SIMILAR TO IEC TYPE C, Class II; KR P/N: Q-KR(R)
06. Argentina IRAM 2073 configuration: 2 blades/SIMILAR TO IEC TYPE I; AR P/N: Class II Q-AR(R)
07. China GB 2099 configuration: 2 blades/SIMILAR TO TYPE A, Class II; CN P/N:Q-CN(R)
08. India IS 1293 6A/BS546 configuration: 5A, 3 pins with Dummy Ground, Class II/IEC TYPE D; IN P/N: Q-IN(R)
09. IEC320/C18 Inlet, Class II; P/N: Q-C18(R)
10. Brazilian NBR6147 configuration: 2 pins, Class II;SIMILAR TO IEC TYPE C BR P/N: Q-BR(R)
11. South Africa SABS164-1, 3 round prongs, Class II + dummy ground, IEC TYPE M P/N: Q-SANS164-1-16A(R)
12. South Africa SABS164-4, 3 round prongs with a notched prong @ 0°, Class II + dummy ground, IEC TYPE M Red, P/N: Q-SANS164-4L-16A(R)
13. South Africa SABS164-4, 3 round prongs with a notched prong @ -53°, Class II + dummy ground, Blue, IEC TYPE M,

### PROPRIETARY INFORMATION

PROPRIETARY OF GLOBTEK, INC. ANY REPRODUCTION, DISCLOSURE OR USE OF THIS DRAWING, IN WHOLE OR IN PART, IS HEREBY PROHIBITED EXCEPT AS SPECIFIED IN WRITING BY GLOBTEK, INC.

<http://en.globtek.com/datasheet/id/a0Oa00000MEtde>



Delivering leading edge, innovative power solutions for more than **30** years....

Model:GTM46101-WVVV-X.X-USB

June 6, 2020

P/N:  
Q-SANS164-4C-16A(R)  
14. South Africa SABS164-4, 3 round prongs with a notched prong @ +53°, Class II + dummy ground, Black,IEC TYPE M  
P/N:  
Q-SANS164-4R-16A(R)

Kits

01. Q-KIT: 1,2,3,4 above  
02. Q-KIT-INTL: 2,3,4 above  
03. Q-KIT-6: 1,2,3,4,5,6 above  
04. Q-KIT-7: 1,2,3,4,5,6,7 above  
05. Q-KIT-8: 1,2,3,4,5,6,7,8 above

---

Delivering leading edge, innovative power solutions for more than 30 years....

Model:GTM46101-WVVV-X.X-USB

June 6, 2020

**OUTPUT CONFIGURATION**

Common output connector options:

 L Type (Coaxial  
5.5x2.5mm plug)

 C Type (Coaxial  
5.5x2.1mm plug)

 K Type (Coaxial  
3.5x1.3mm plug)

 LL Type (5.5x2.5mm  
Locking 760k type)

 CL Type (5.5x2.1mm  
Locking S761k type)

 ML2 Type (Molex  
housing 43025-0200)

 YL3 Type  
(KPPX-3P)

YL4 Type (KPPX-4P)

 EJ1/2/3/4/5 (EIAJ  
RC-5320A type  
connectors)

 MSB Type (Micro  
USB)

 USBC Type (USB  
Type C)

 Inquire for custom  
design

 For a comprehensive list of options, [click here](#)

Contact GlobTek for your specific requirements or custom solutions.

Delivering leading edge, innovative power solutions for more than 30 years....

Model:GTM46101-WWVV-X.X-USB

June 6, 2020





## Approvals

Logo	Description
No Logo Applicable	CB report IEC60601-1 2005 A1+C1+C2 2016-2-4 and or EN 60601-1:2006 3.1rd Edition 2xMOPP
No Logo Applicable	CB for IEC 62368-1:2014 (Second Edition)
No Logo	CB Report IEC60950-1:2005 (2nd Edition), Am 1: 2009 + Am 2:2013
No Logo Applicable	CB to 60335-1 5th Edition (Safety of Household and Similar Electrical Appliances, Part 1: General Requirements) CB Report/ Certificate IEC 60335-1:2010 Up to 36 volts only
 5000	CCC Altitude up to 5000 m GB17625.1-2012, GB4943.1-2011, GB/T9254-2008
	CE Certification CE Mark: tested to comply with EN 55032.2012+AC.2013 EN 61000-3-2.2014 EN 61000-3-3.2013 EN 60601-1-2.2013(Ed4) EN 55024.2010
	CE Mark: tested to comply with EN60601-1-2:2013 (4th Ed), EN61000-3-2, EN61000-3-3, EN50082-1, including EN61000-4-2, EN61000-4-3, EN61000-4-4, EN61000-4-5, EN61000-4-6, EN61000-4-8, EN61000-4-11, EN61000-1-2-2001 EMI: EN55011 CLASS B and FCC Part 15 B
	Audio/Video, Information And Communication Technology Equipment - Part 1: Safety Requirements [UL 62368-1:2014 Ed.2] Audio/Video, Information And Communication Technology Equipment - Part 1: Safety Requirements [CSA C22.2#62368-1:2014 Ed.2]
Conforms to ANSI/AAMI ES 60601-1:2005 Cert.to CAN/CSA Std. C22.2	cETLus ANSI_AAMI ES60601-1_2005
	Medical Electrical Equipment - Part 1: General Requirements For Basic Safety And

Delivering leading edge, innovative power solutions for more than 30 years....

Model:GTM46101-WVVV-X.X-USB



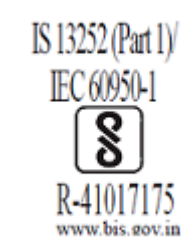



June 6, 2020

	Essential Performance [AAMI ES60601-1:2005 +A1]Medical Electrical Equipment - Part 1: General Requirements For Basic Safety And Essential Performance [CSA C22.2#60601-1:2014
	Information Technology Equipment Safety Part 1: General Requirements (UL 60950-1 Issued: 2007/03/27 Ed: 2 Rev: 2014/10/14) Information Technology Equipment Safety Part 1: General Requirements (CSA C22.2 No. 60950-1 Issued:2007/03/27 Ed: 2 (R2012) Amd. 1
	CHINA SJ/T 11364-2014, China RoHS Chart: <a href="http://en.globtek.com/globtek-rohs.php">http://en.globtek.com/globtek-rohs.php</a>
	Declaration ДС № EAЭC N RU Д-US.KA01.B.10453_19 Custom Union of Russia, Belarus and Kazakhstan <a href="http://www.globtek.com/redirect/?loc=gost-certificate-eac-declaration">http://www.globtek.com/redirect/?loc=gost-certificate-eac-declaration</a>
	Compliance of this power supply with FCC Part 15, Class B has been demonstrated with a standard output load. The FCC law stipulates that system-level testing is required to demonstrate compliance with the FCC emission limits with the actual system load.
CAN ICES-3(B)/NMB-3(B)	Compliance of this PSU with Industry Canada, Class B demonstrated with a standard output load. The ICES law stipulates that system-level testing is required to demonstrate compliance with the ICES-3 emission limits with the actual system load.
	Bureau Of Indian Standards for GTM46101-1005-USB (5V only)
IP20	Ingress Protection: IP20 to IEC60529:2001 Protected against solids objects over 12mm and No Protection
	JAPAN TUV R-PSE, Cert. No. JD 50315169, to J60950-1(H26) , J55022(H22),[15V

Delivering leading edge, innovative power solutions for more than 30 years....

Model:GTM46101-WVVV-X.X-USB

June 6, 2020

 GlobTek, Inc.	or less]. Please reference the following website for guidelines on PSE regulations: <a href="http://en.globtek.com/importing-ite-and-medical-power-supplies-ac-adaptors-to-japan/">http://en.globtek.com/importing-ite-and-medical-power-supplies-ac-adaptors-to-japan/</a>
 직류전원장치 AC/DC ADAPTER KTC HU10499-20042A R-R-GBZ-0006 전기용품안전관리법에 의한 표시 최저소비효율기준 만족 제품 모델명:GTM46101-1306-0.5-USB Mfr. Name: GLOBTEK (SUZHOU) CO.,LTD A/S Center:10-6221-6100	Korea HU10499-20042A (for GTM46101-USB) 5V-5.4V
EFFICIENCY LEVEL 	Efficiency: complies to section 301 of Energy Independence and Security Act (EISA) complies with Energy Star tier 2 (North America), ECP tier 2 (China), MEPS tier 2 (Australia), Code of Conduct (Europe)
LPS	Limited Power Source 60950
	Morocco SDoC declaration <a href="http://www.globtek.info/certs/Morocco%20SDoC%20Declaration/">http://www.globtek.info/certs/Morocco%20SDoC%20Declaration/</a>
No Logo	SANS IEC 60950-1
	RCM certificate SAA-152394-EA; Australia and New Zealand Regulatory Compliance, Mark ( <a href="http://rcm.standards.org.au/rcmfaq/rcmfaq.htm">http://rcm.standards.org.au/rcmfaq/rcmfaq.htm</a> )
RoHS	Specifications of directive 2011/65/EU Annex VI (ROHS-2) with amendment 2015/863-EU (ROHS-3) <a href="http://www.ce-mark.com/Rohs%20final.pdf">http://www.ce-mark.com/Rohs%20final.pdf</a>
	Semko S-Mark-Cert-EN60601-1 3.1rd Edition ( <a href="http://www.intertek.com/marks/s/">http://www.intertek.com/marks/s/</a> )
	Ukraine UKRSepro (Document: <a href="http://www.globtek.com/html/iso_certificates/GT_Ukraine.pdf">www.globtek.com/html/iso_certificates/GT_Ukraine.pdf</a> )