

Delivering leading edge, innovative power solutions for more than 30 years....

Model:GT-86182-WWVV-WF2A-USB

November 30, 2021

GT-86182-WWVV-WF2A-USB

Information

Model Number	GT-86182-WWVV-WF2A-USB
Description	Quick Charge 2.0 & 3.0 BC1.2, APPLE 2.4A., SAMSUNG 2.0A, FCP, SFCP, AFC

Model Picture



Agency Documents	http://www.globtek.info/certs/GT-86182-W(F)2-USB/
CE EC-Declaration	https://www.globtek.com/pdf/ec_declaration/a003a00000Lx1k7EAB
RoHS/RoHS2 Declaration	https://www.globtek.com/pdf/rohs_cert/a003a00000Lx1k7EAB
REACH Declaration	https://www.globtek.com/pdf/iso_certificates/REACH.pdf
Conflict Minerals Declaration	https://www.globtek.com/pdf/conflict-minerals.pdf

Delivering leading edge, innovative power solutions for more than **30** years....

Model:GT-86182-WWVV-WF2A-USB

November 30, 2021

MODEL PARAMETERS

Type	Wall Plug-in
Technology	USB Adaptive Power Supply AC Adaptor
Category	ICT/ITE Power Supply
Input Voltage	100-240V~, 50/60Hz
I/P Amps (A)	0.6 A
Wattage (W)	18.0
Vout Range (V)	5/9/12V_QC3.0, BC1.2, APPLE 2.4A., SAMSUNG 2.0A, FCP, SFCP, AFC
Efficiency Level	USA DOE Level VI / Eco-design Directive 2009/125/EC, (EU) 2019/1782
Ingress Protection	Indoor Use
Size (mm)	76 (L) * 40 (W) *28.9(H)

PROPRIETARY INFORMATION

PROPRIETARY OF GLOBTEK, INC. ANY REPRODUCTION, DISCLOSURE OR USE OF THIS DRAWING, IN WHOLE OR IN PART, IS HEREBY PROHIBITED EXCEPT AS SPECIFIED IN WRITING BY GLOBTEK, INC.

<https://www.globtek.com/datasheet/w70588>

Delivering leading edge, innovative power solutions for more than 30 years....

Model:GT-86182-WWVV-WF2A-USB

November 30, 2021

ENCLOSURE

Case: Black

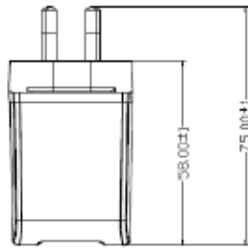
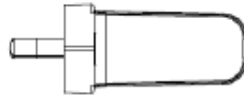
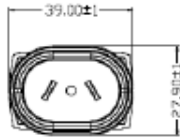
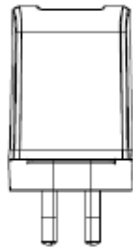

Delivering leading edge, innovative power solutions for more than **30** years....

Model:GT-86182-WWVV-WF2A-USB

November 30, 2021

RATING TABLE

Model Number	Voltage	Amps(A)	Watts(W)	RFQ
GT-86182-1812-WF2A-USB	5,9,12 V	1.5	18.00	RFQ

Model:GT-86182-WWVV-WF2A-USB

November 30, 2021

SPECIFICATIONS

A) ELECTRICAL SPECIFICATIONS:

01. Input Voltage: Specified 90-264 Vac, Nameplate rated: 100-240Vac
02. Input Frequency: Specified 47-63 Hz, Nameplate rated 50-60Hz
03. Inrush Current: at full load, 25° C, cold start
04. Efficiency: Compliant with Efficiency Level VI and ErP European Commission's Ecodesign Directive (2005/32/EC) / CoC Tier 2 Compliant
05. No Load Standby Power: <math><0.075W @ 230Vac</math>
06. Line regulation: $\pm 2\%$ At nominal input voltage and full load
07. Total output regulation: $\pm 5\%$
08. Output Voltage: Tolerance $\pm 5\%$
09. Turn On Delay: 3 Seconds maximum at nominal input Voltage
10. Hold Up Time: 5ms min at nominal Input Voltage
11. Ripple Voltage: 200 mVp-p At 20 MHz, and output parallel with 0.1uF & 10uF capacitors to ground Temperature at 25°C, and nominal input voltage
12. Compliant with CLASS A Qualcomm Quick Charge 3.0 and Quick Charge 2.0. 3.6V~12V DC with 18 watts maximum output. Also compliant with BC1.2, APPLE 2.4A., SAMSUNG 2.0A, FCP, SFCP, AFC

Quick Charger 3.0 protocol

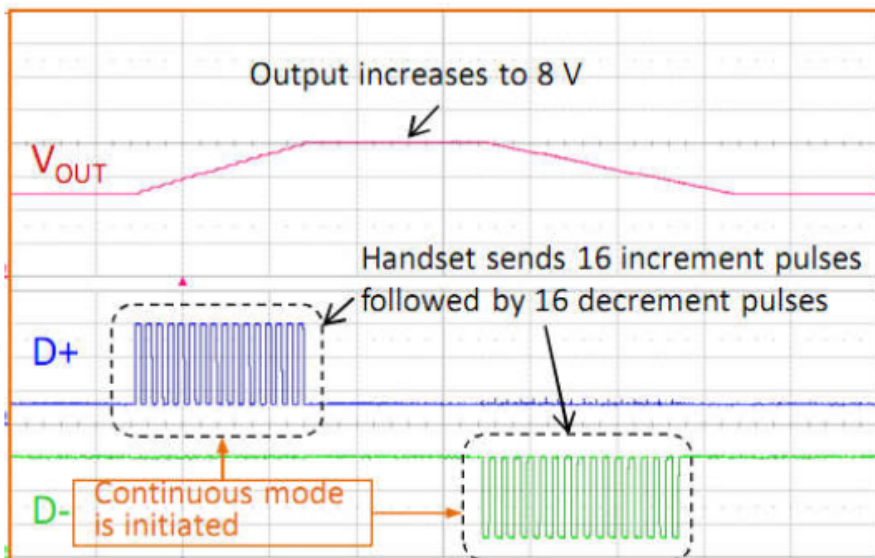

B) PROTECTION

01. Over voltage protection: Output shut down and auto restart
02. Short circuit protection: The adapter shall not be damaged by short the DC output to Ground
03. Over Load Protection: Output shut down and auto restart

C) SAFETY

01. HI-POT : Input to output : 3000VAC or 4242VDC 10mA 1 minute

PROPRIETARY INFORMATION

PROPRIETARY OF GLOBTEK, INC. ANY REPRODUCTION, DISCLOSURE OR USE OF THIS DRAWING, IN WHOLE OR IN PART, IS HEREBY PROHIBITED EXCEPT AS SPECIFIED IN WRITING BY GLOBTEK, INC.

<https://www.globtek.com/datasheet/w70588>

Delivering leading edge, innovative power solutions for more than 30 years....

Model:GT-86182-WWVV-WF2A-USB

November 30, 2021

- 02. Leakage current: 0.25mA maximum, at nominal AC input voltage and frequency
- 03. ESD: 8KV(air) / 4KV (contact)

D) EMC

- 01. Emissions, per EN 55032, EN 61000-6-3, EN 61000-6-4
 - Conducted Emissions: Class B, FCC Part 15, Class B
 - Radiated Emissions: Class B, FCC Part 15, Class B
- 02. Line Frequency Harmonics EN61000-3-2, Class A
- 03. Voltage Fluctuations/Flicker EN61000-3-3
- 04. Immunity, per EN 55024, EN 61000-6-1, EN 61000-6-2
 - Static Discharge Immunity EN61000-4-2, 4kV Contact Discharge, 8kV air discharge
 - Radiated RF Immunity EN61000-4-3, 3V/m 80-1000MHz, 80% 1KHz AM.
 - EFT/Burst Immunity EN61000-4-4, 1kV/100kHz.
 - Line Surge Immunity EN61000-4-5, 1kV differential, 2kV common-mode
 - Conducted RF Immunity EN61000-4-6, 3Vrms, 80% 1KHz AM
 - Power Frequency Magnetic Field Immunity EN61000-4-8, 1A/m
 - Voltage Dip Immunity EN61000-4-11, Criteria

E) OTHER:

- 01. MTBF: 200,000 Hours @ 25°C ambient temperature
- 02. Operating Temperature: 0°C to 40°C ambient temperature
- 03. Humidity Operating : 20% to 85%
- 04. Storage Temperature: -20°C to 60°C
- 05. RoHS 2: Complies with EU 2011/65/EU and China GB/T26572-2011

F) ENCLOSURE

- 01. Housing: High impact plastic, 94V0 polycarbonate, non-vented
- 02. Size: 38.7 (L) * 23.7 (W) * 51.5(H) mm maximum
- 03. Weight : 48.0 g
- 04. Markings: Label and/or Pad Printed and/or Molded in the case

Delivering leading edge, innovative power solutions for more than 30 years....

Model:GT-86182-WWVV-WF2A-USB

November 30, 2021

DERATING CURVE

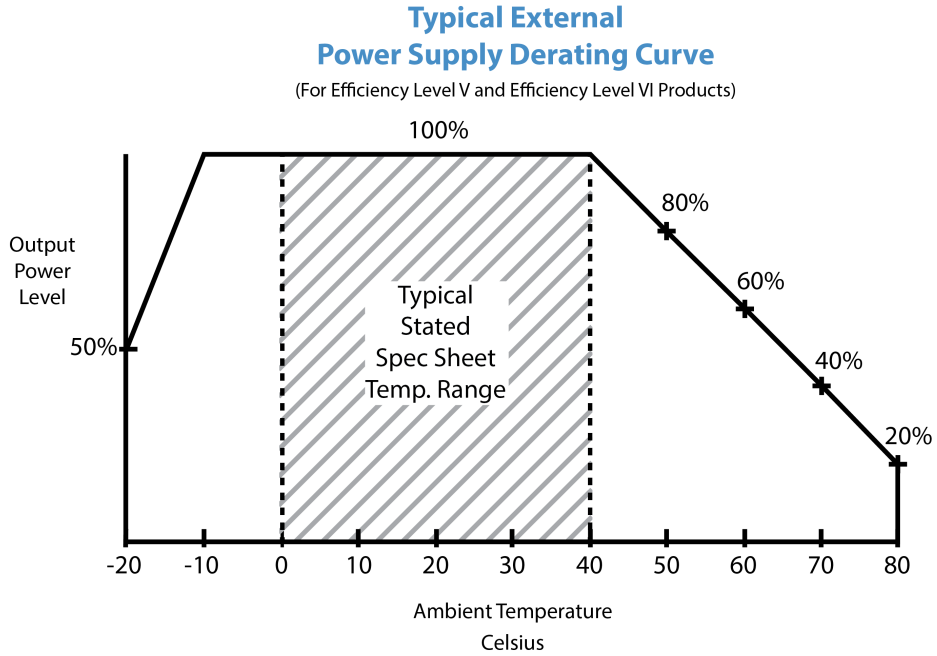

Delivering leading edge, innovative power solutions for more than 30 years....

Model:GT-86182-WWVV-WF2A-USB

November 30, 2021

INPUT CONFIGURATION

Description Australian AS 3112 configuration: SAA 2 pins Class II

Used in [Australia](#), [New Zealand](#), [Fiji](#), [Papua New Guinea](#) and [Tokelau](#), has two flat pins forming an inverted V-shape. These flat blades measure 6.3 by 1.5 mm with the Active and Neutral pins of 17 mm in length set 30° to the vertical on a nominal pitch of 13.7 mm. A standard power outlet in Australia provides a nominal voltage of 230 volts at a maximum of 10 amps and always includes an earth connection. As in the UK, its outlets are individually switched for extra safety. [Argentina](#) uses a similar plug, with pins 1 mm longer.

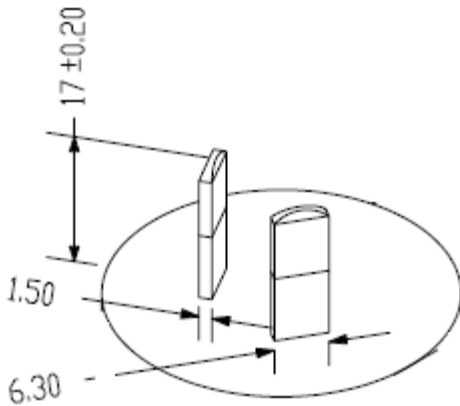

Delivering leading edge, innovative power solutions for more than 30 years....

Model:GT-86182-WWVV-WF2A-USB

November 30, 2021

OUTPUT CONFIGURATION

Common output connector options:

 L Type (Coaxial
5.5x2.5mm plug)

 C Type (Coaxial
5.5x2.1mm plug)

 K Type (Coaxial
3.5x1.3mm plug)

 LL Type (5.5x2.5mm
Locking 760k type)

 CL Type (5.5x2.1mm
Locking S761k type)

 ML2 Type (Molex
housing 43025-0200)

 YL3 Type
(KPPX-3P)

YL4 Type (KPPX-4P)

 EJ1/2/3/4/5 (EIAJ
RC-5320A type
connectors)

 MSB Type (Micro
USB)

 USBC Type (USB
Type C)

 Inquire for custom
design

 For a comprehensive list of options, [click here](#)







Contact GlobTek for your specific requirements or custom solutions.

Delivering leading edge, innovative power solutions for more than **30** years....

Model:GT-86182-WWVV-WF2A-USB

November 30, 2021

Approvals

Logo	Description
	CHINA SJ/T 11364-2014, China RoHS Chart: http://en.globtek.com/globtek-rohs.php
	
	Declaration ДС № EAЭC N RU Д-US.KA01.B.10453_19 Custom Union of Russia, Belarus and Kazakhstan http://www.globtek.com/redirect/?loc=gost-certificate-eac-declaration
	Indoor Use Only - Mark is on the label or Molded in the case
LPS	Limited Power Source 60950
RoHS	Specifications of directive 2011/65/EU Annex VI (ROHS-2) with amendment 2015/863-EU (ROHS-3) http://www.ce-mark.com/Rohs%20final.pdf
 10276	Ukraine UKRSepr (Document: www.globtek.com/html/iso_certificates/GT_Ukraine.pdf)
	WEEE: Complies with EU 2012/19/EU (http://ec.europa.eu/environment/waste/wEEE/index_en.htm) Mark is on the label or Molded in the case