

Delivering leading edge, innovative power solutions for more than 30 years....

Model:GT-86120-WWVV-X.X-W2B

June 6, 2020

## GT-86120-WWVV-X.X-W2B

### Information

Model Number	GT-86120-WWVV-X.X-W2B
Description	GT-86120-WWVV-X.X-W2B, ITE Power Supply, Wall Plug-in, Regulated Switchmode AC-DC Power Supply AC Adaptor, , Input Rating: 100-240V- , 50/60Hz, The Brazilian NBR 14136:2002 is standard for Brazilian plugs and receptacle, Output Rating: 12 Watts, Power rating with convection cooling (W) , 4.2V-12VV in 0.1V increments, Approvals: CB 60950; China RoHS; Double Insulation; Level VI; LPS 60950; RoHS; Ukraine; WEEE; EAC;

### Model Picture



Agency Documents	<a href="http://www.globtek.info/certs/GT-86120-WWVV-W2Z/">http://www.globtek.info/certs/GT-86120-WWVV-W2Z/</a>
CE EC-Declaration	<a href="https://www.globtek.com/pdf/ec_declaration/a000c00000PHJ0iEAH">https://www.globtek.com/pdf/ec_declaration/a000c00000PHJ0iEAH</a>
RoHS/RoHS2 Declaration	<a href="https://www.globtek.com/pdf/rohs_cert/a000c00000PHJ0iEAH">https://www.globtek.com/pdf/rohs_cert/a000c00000PHJ0iEAH</a>
REACH Declaration	<a href="https://www.globtek.com/pdf/iso_certificates/REACH.pdf">https://www.globtek.com/pdf/iso_certificates/REACH.pdf</a>
Conflict Minerals Declaration	<a href="https://www.globtek.com/pdf/conflict-minerals.pdf">https://www.globtek.com/pdf/conflict-minerals.pdf</a>

Delivering leading edge, innovative power solutions for more than **30** years....

Model:GT-86120-WWVV-X.X-W2B

June 6, 2020

**MODEL PARAMETERS**

Type	Wall Plug-in
Technology	Regulated Switchmode AC-DC Power Supply AC Adaptor
Category	ITE Power Supply
Input Voltage	100-240V~, 50/60Hz
I/P Amps (A)	0.5A
Wattage (W)	12.0
Vout Range (V)	4.2V-12V
Efficiency Level	USA DOE Level VI / Eco-design Directive 2009/125/EC, (EU) 2019/1782
Ingress Protection	IPX0
Size (mm)	69*28.8*58.3

Delivering leading edge, innovative power solutions for more than 30 years....

Model:GT-86120-WWVV-X.X-W2B

June 6, 2020

# ENCLOSURE

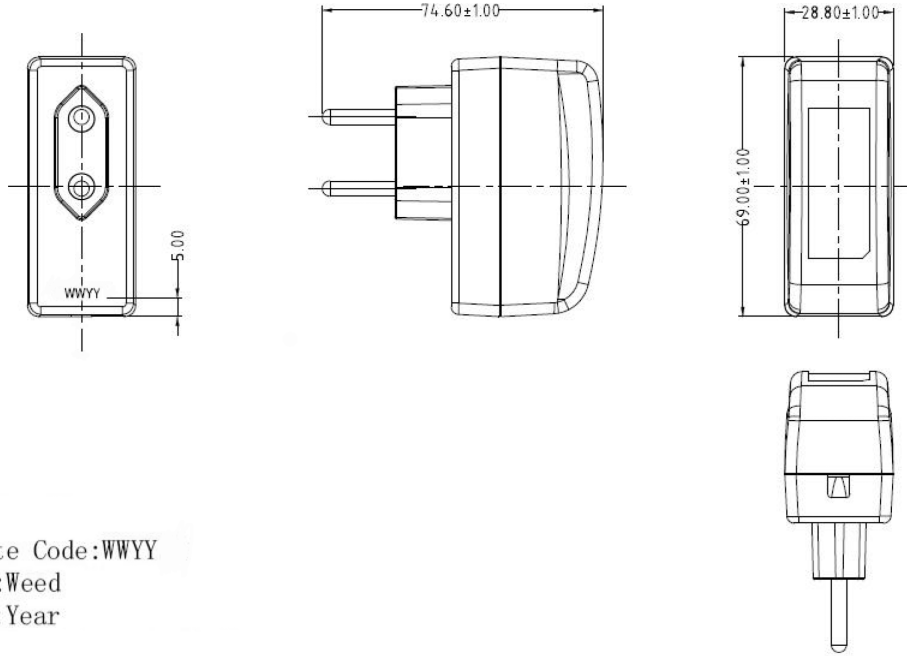

Date Code:WWYY  
WW:Week  
YY:Year

Delivering leading edge, innovative power solutions for more than **30** years....

Model:GT-86120-WWVV-X.X-W2B

June 6, 2020

**RATING TABLE**

Model Number	Voltage	Amps(A)	Watts(W)	RFQ
--------------	---------	---------	----------	-----

## SPECIFICATIONS

### ELECTRICAL SPECIFICATIONS:

01. Input Voltage: Specified 90-264 Vac, Nameplate rated: 100-240Vac
02. Input Frequency: Specified 47-63 Hz, Nameplate rated 50-60Hz
03. Output Regulation: +/- 5%
04. Ripple and Noise (Vp-p): 100 mVp-p maximum, At 20 MHz, and output parallel with 0.1uF & 47uF capacitors to ground. Temperature at 25 °C, and nominal input voltage
05. Efficiency: Compliant with Efficiency Level VI and ErP European Commission's Ecodesign Directive (2005/32/EC) / CoC Tier 2 Compliant
06. No Load Standby Power: <0.075W @ 230Vac
07. Turn-ON Delay: 3 Seconds maximum at nominal input voltage
08. Rise Time: 100mS maximum at nominal input voltage

### B) PROTECTION

01. Over-Voltage: 10VDC maximum
02. Over current protection: 4A maximum with auto-recovery function
03. Short Circuit: Short circuit protection is to be included in the construction of the adaptor. The adaptor is designed to withstand continuous current of a short circuit on the output. The adaptor will be short circuit tolerant for an indefinite period.

### C) SAFETY

01. Dielectric Withstand Voltage: 3000VAC 10mA 1minute or 4242VDC 10mA 1minute from primary to secondary
02. Leakage current: 0.25mA maximum, at nominal AC input voltage and frequency
03. Static Discharge Immunity of 8kV Contact Discharge, 15kV air discharge.

### D) EMC

01. Emissions, per EN 55032, EN 61000-6-3, EN 61000-6-4
  - Conducted Emissions: Class B, FCC Part 15, Class B
  - Radiated Emissions: Class B, FCC Part 15, Class B
02. Line Frequency Harmonics EN61000-3-2, Class A
03. Voltage Fluctuations/Flicker EN61000-3-3
04. Immunity, per EN 55024, EN 61000-6-1, EN 61000-6-2
  - Static Discharge Immunity EN61000-4-2, 4kV Contact Discharge, 8kV air discharge
  - Radiated RF Immunity EN61000-4-3, 3V/m 80-1000MHz, 80% 1KHz AM.
  - EFT/Burst Immunity EN61000-4-4, 1kV/100kHz.
  - Line Surge Immunity EN61000-4-5, 1kV differential, 2kV common-mode
  - Conducted RF Immunity EN61000-4-6, 3Vrms, 80% 1KHz AM
  - Power Frequency Magnetic Field Immunity EN61000-4-8, 1A/m
  - Voltage Dip Immunity EN61000-4-11, Criteria

### E) OTHER:

01. MTBF: 200,000 Hours @ 25°C ambient temperature
02. Operating Temperature: 0°C to 50°C ambient temperature (RFP7139)
03. Humidity: 5% to 90% relative humidity
04. Storage Temperature: -20°C to 60°C
05. Cooling: natural convection cooling
06. ROHS 2: Complies with EU 2011/65/EU and China SJ/T 11363-2006

### PROPRIETARY INFORMATION

PROPRIETARY OF GLOBTEK, INC. ANY REPRODUCTION, DISCLOSURE OR USE OF THIS DRAWING, IN WHOLE OR IN PART, IS HEREBY PROHIBITED EXCEPT AS SPECIFIED IN WRITING BY GLOBTEK, INC.

<http://en.globtek.com/datasheet/id/a000c00000PHJ0i>

Delivering leading edge, innovative power solutions for more than **30** years....

Model:GT-86120-WWVV-X.X-W2B

June 6, 2020

## F) ENCLOSURE

01. Housing: High impact plastic, 94V0 polycarbonate, non-vented

02. Markings: Label and/or Pad Printed and/or Molded in the case

Delivering leading edge, innovative power solutions for more than **30** years....

Model:GT-86120-WWVV-X.X-W2B

June 6, 2020

## DERATING CURVE



Delivering leading edge, innovative power solutions for more than **30** years....

Model:GT-86120-WWVV-X.X-W2B

June 6, 2020

**INPUT CONFIGURATION**

Description The Brazilian NBR 14136:2002 is standard for Brazilian plugs and receptacle

This standard is based on the international IEC 60906-1 standard, developed to encourage countries to adopt one plug and receptacle for global use. The standard does not include a medical grade plug. Brazil uses 110-220 Volts and 60 Hz.



Delivering leading edge, innovative power solutions for more than 30 years....

Model:GT-86120-WVVV-X.X-W2B

June 6, 2020

**OUTPUT CONFIGURATION**

Common output connector options:

 L Type (Coaxial  
5.5x2.5mm plug)

 C Type (Coaxial  
5.5x2.1mm plug)

 K Type (Coaxial  
3.5x1.3mm plug)

 LL Type (5.5x2.5mm  
Locking 760k type)

 CL Type (5.5x2.1mm  
Locking S761k type)

 ML2 Type (Molex  
housing 43025-0200)

 YL3 Type  
(KPPX-3P)

YL4 Type (KPPX-4P)

 EJ1/2/3/4/5 (EIAJ  
RC-5320A type  
connectors)

 MSB Type (Micro  
USB)

 USBC Type (USB  
Type C)

 Inquire for custom  
design

 For a comprehensive list of options, [click here](#)







Contact GlobTek for your specific requirements or custom solutions.

Delivering leading edge, innovative power solutions for more than **30** years....

Model:GT-86120-WWVV-X.X-W2B

June 6, 2020

## Approvals

Logo	Description
	Attention Mark / Refer to operating manual for operating and service instructions
No Logo Applicable	CB report to IEC 60950-1:2005 (2nd Edition) +A1:2009 + A2:2013
	CHINA SJ/T 11364-2014, China RoHS Chart: <a href="http://en.globtek.com/globtek-rohs.php">http://en.globtek.com/globtek-rohs.php</a>
	Declaration ДС № EAЭC N RU Д-US.KA01.B.10453_19 Custom Union of Russia, Belarus and Kazakhstan <a href="http://www.globtek.com/redirect/?loc=gost-certificate-eac-declaration">http://www.globtek.com/redirect/?loc=gost-certificate-eac-declaration</a>
	Indoor Use Only - Mark is on the label or Molded in the case
EFFICIENCY LEVEL 	Efficiency: complies to section 301 of Energy Independence and Security Act (EISA) complies with Energy Star tier 2 (North America), ECP tier 2 (China), MEPS tier 2 (Australia), Code of Conduct (Europe)
LPS	Limited Power Source 60950
RoHS	Specifications of directive 2011/65/EU Annex VI (ROHS-2) with amendment 2015/863-EU (ROHS-3) <a href="http://www.ce-mark.com/Rohs%20final.pdf">http://www.ce-mark.com/Rohs%20final.pdf</a>
 10276	Ukraine UKRSepr (Document: <a href="http://www.globtek.com/html/iso_certificates/GT_Ukraine.pdf">www.globtek.com/html/iso_certificates/GT_Ukraine.pdf</a> )

Delivering leading edge, innovative power solutions for more than **30** years....

Model:GT-86120-WWVV-X.X-W2B

June 6, 2020

	WEEE: Complies with EU 2012/19/EU ( <a href="http://ec.europa.eu/environment/waste/weee/index_en.htm">http://ec.europa.eu/environment/waste/weee/index_en.htm</a> ) Mark is on the label or Molded in the case
---	--